

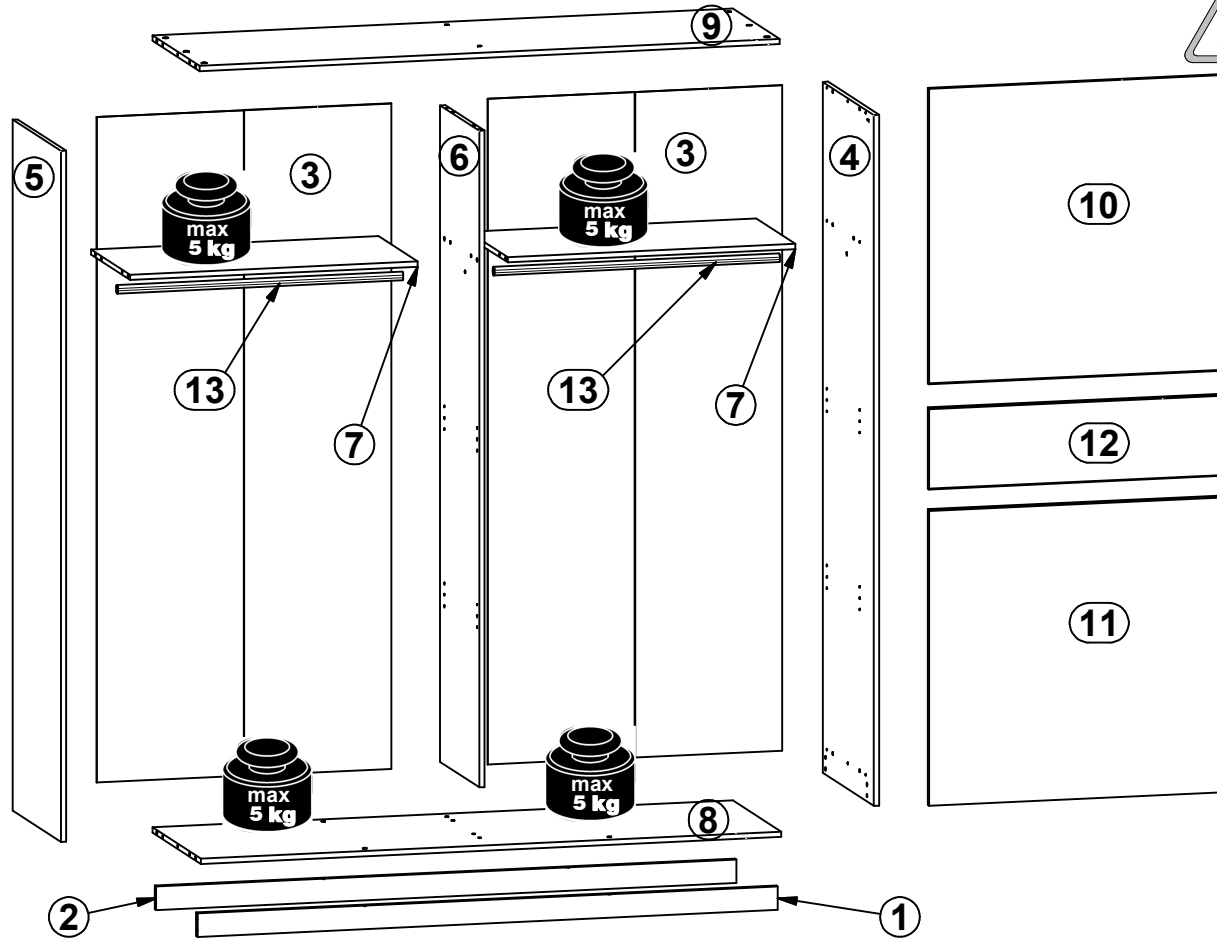

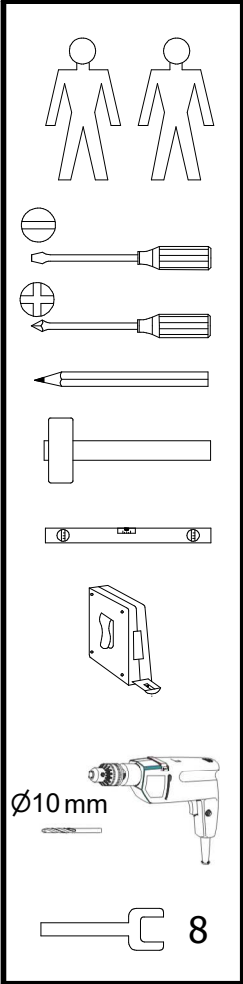

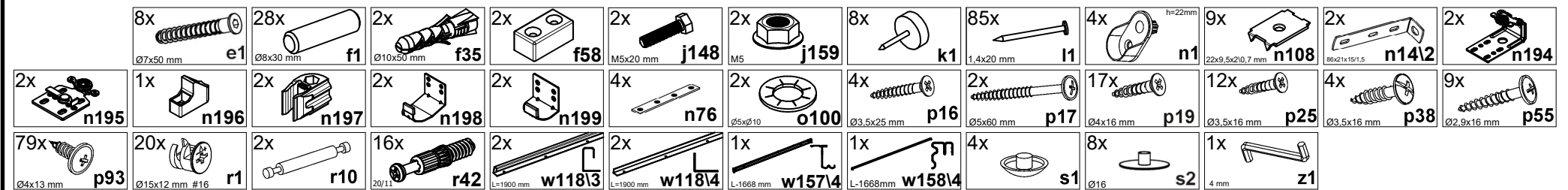

Beschlag in Colli 2

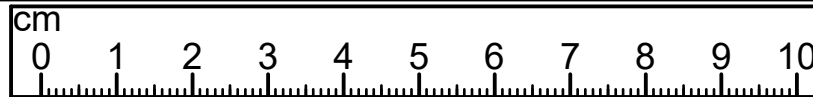
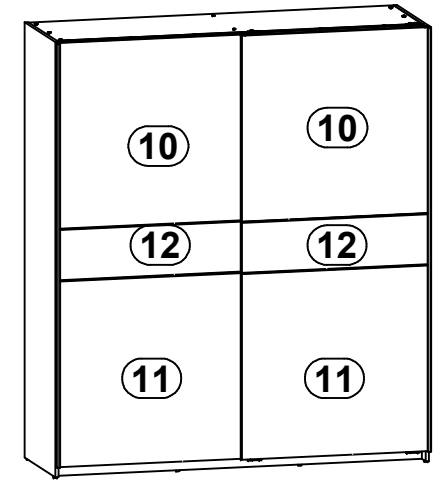
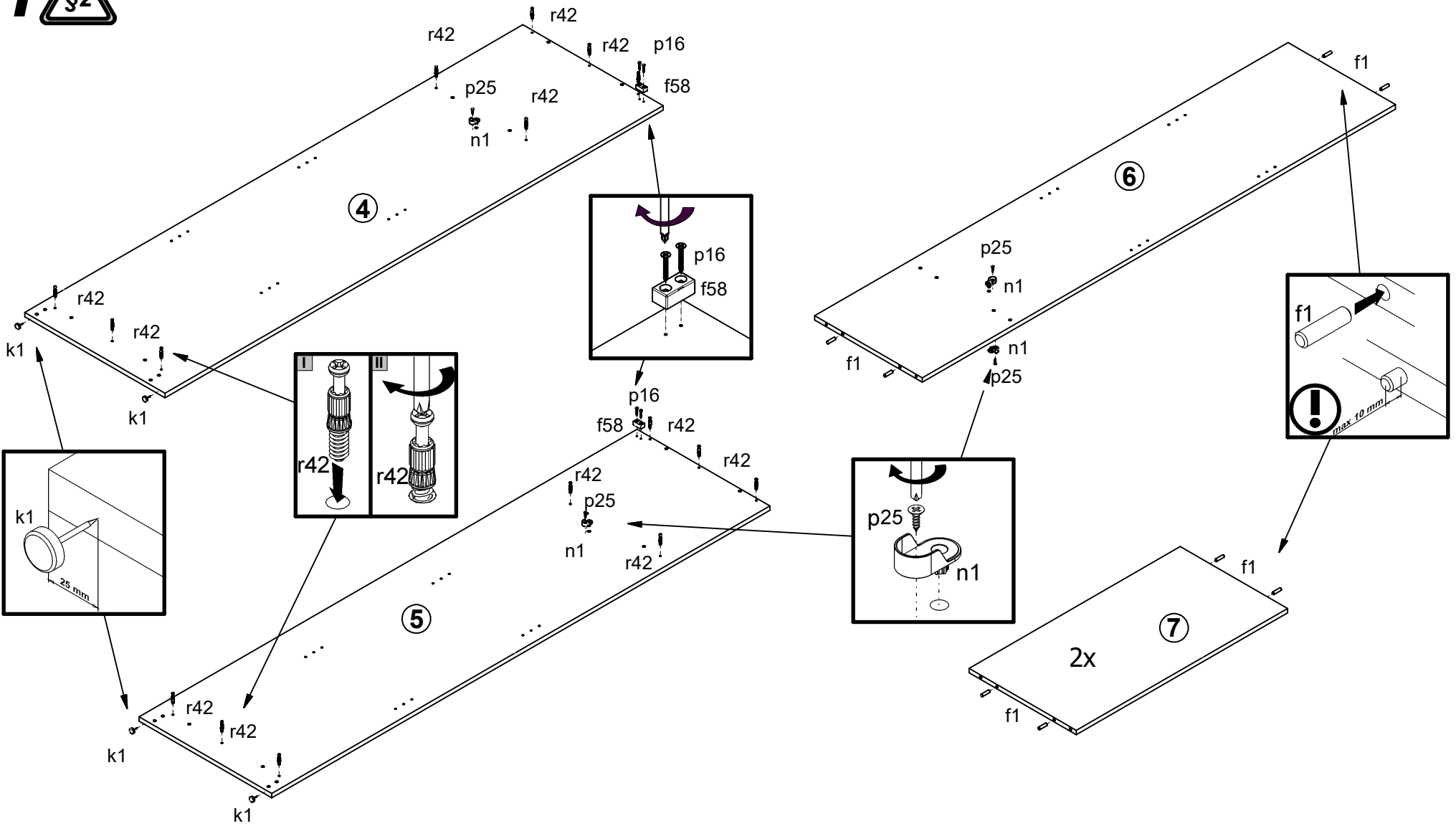

A	B	C (mm)		D	
1	F27-405	1669	66	15	2/3
2	F27-406	1669	66	15	2/3
3	F27-902	1878	847	2,5	1/3
4	F52-101	1950	549	15	1/3
5	F52-102	1950	520	15	1/3
6	F52-103	1853	421	15	1/3
7	F52-301	827	420	15	2/3
8	F52-302	1669	519	15	2/3
9	F52-303	1669	504	15	2/3
10	F52-512	861	835	15	3/3
11	F52-513	861	835	15	3/3
12	F52-514	861	230	15	3/3
13	dr-821	821	22	15	2/3

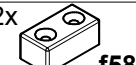

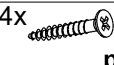

- 12x

Ø8x30 mm f1
- 2x

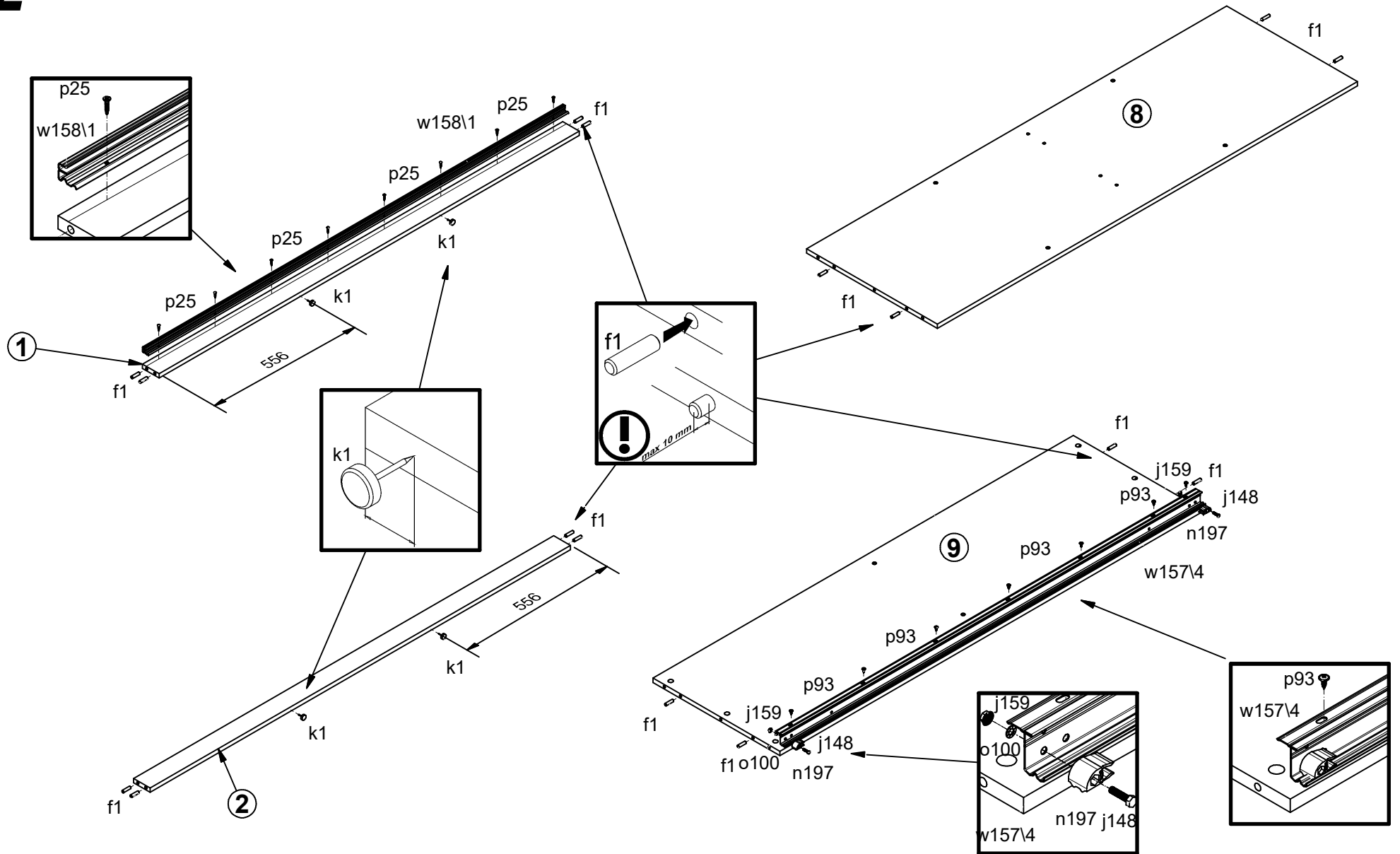
f58
- 4x

k1
- 4x

h=22mm n1
- 4x

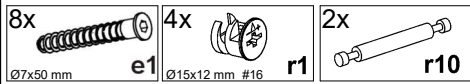
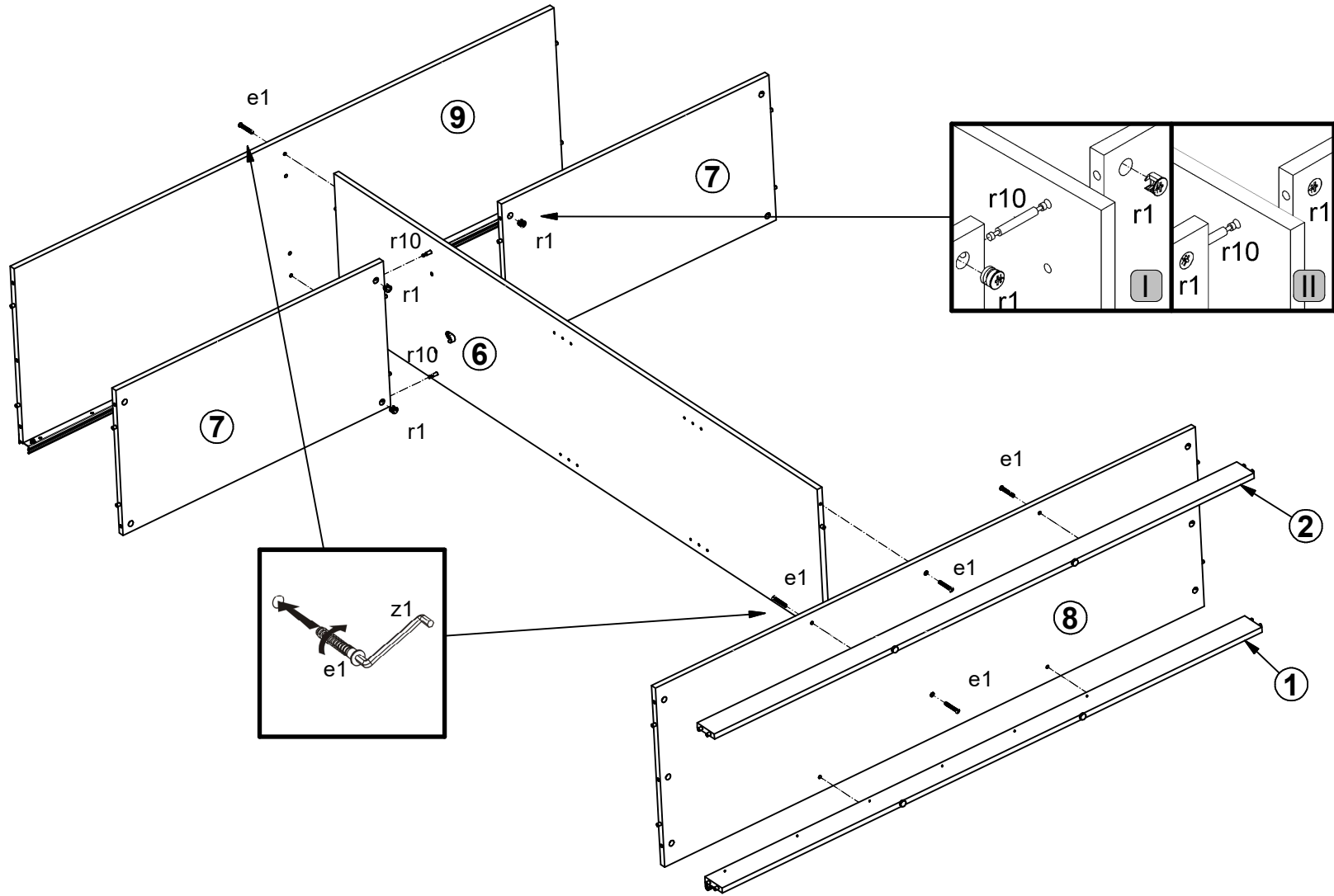
Ø3,5x25 mm p16
- 4x

Ø3,5x16 mm p25
- 16x

20/11 r42

2



- | | | | | | | | | | |
|-----------------------|----------|------------|------------------------|------------------|----------------------|-------------------------|-----------------------|---------------------------|--------------------------|
| 16x
Ø8x30 mm
f1 | 4x
k1 | 2x
n197 | 2x
M5x20 mm
j148 | 2x
M5
j159 | 2x
Ø5xØ10
o100 | 8x
Ø3.5x16 mm
p25 | 7x
Ø4x13 mm
p93 | 1x
L-1668 mm
w157\4 | 1x
L-1668mm
w158\4 |
|-----------------------|----------|------------|------------------------|------------------|----------------------|-------------------------|-----------------------|---------------------------|--------------------------|

3



4

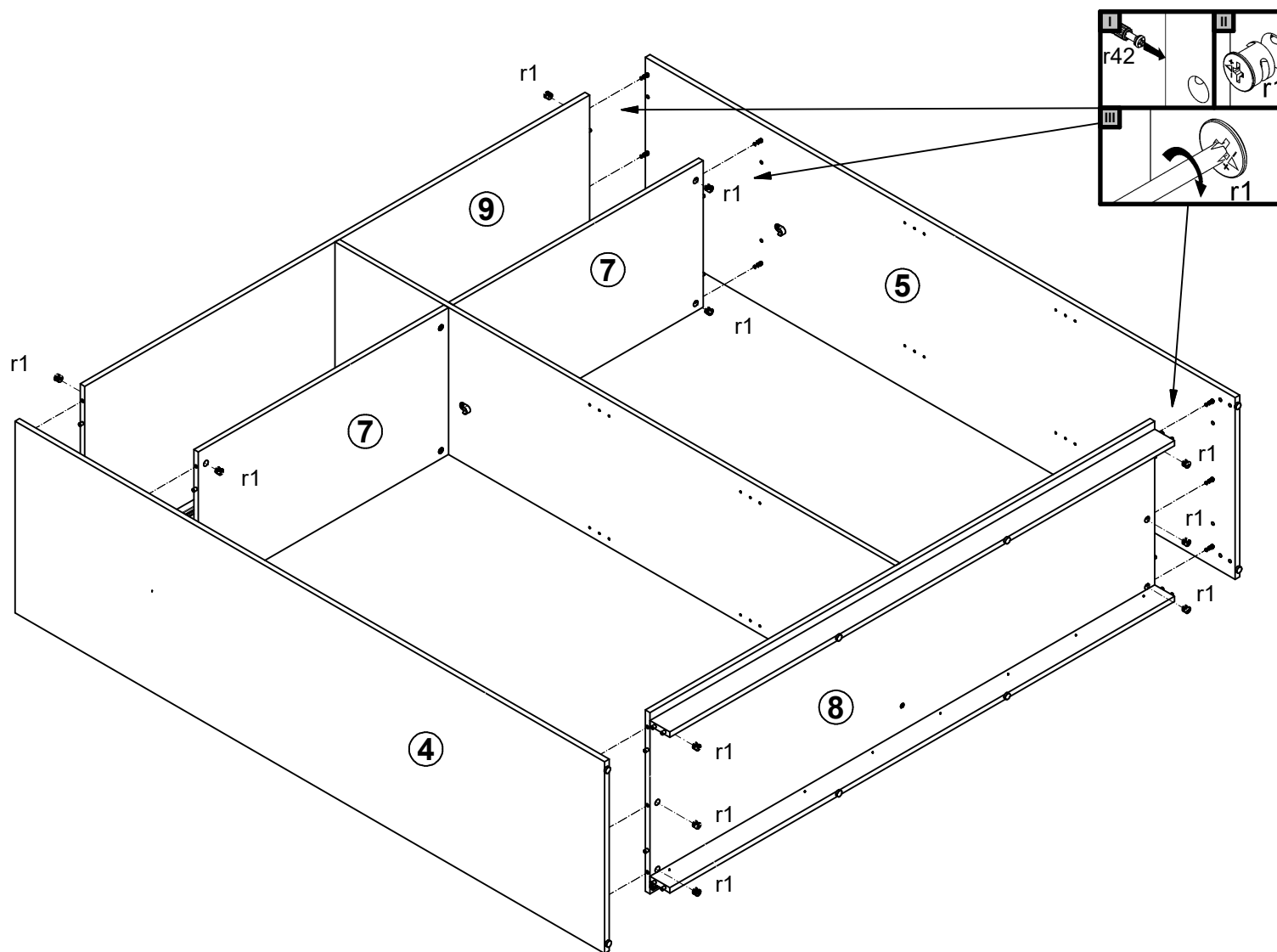

5

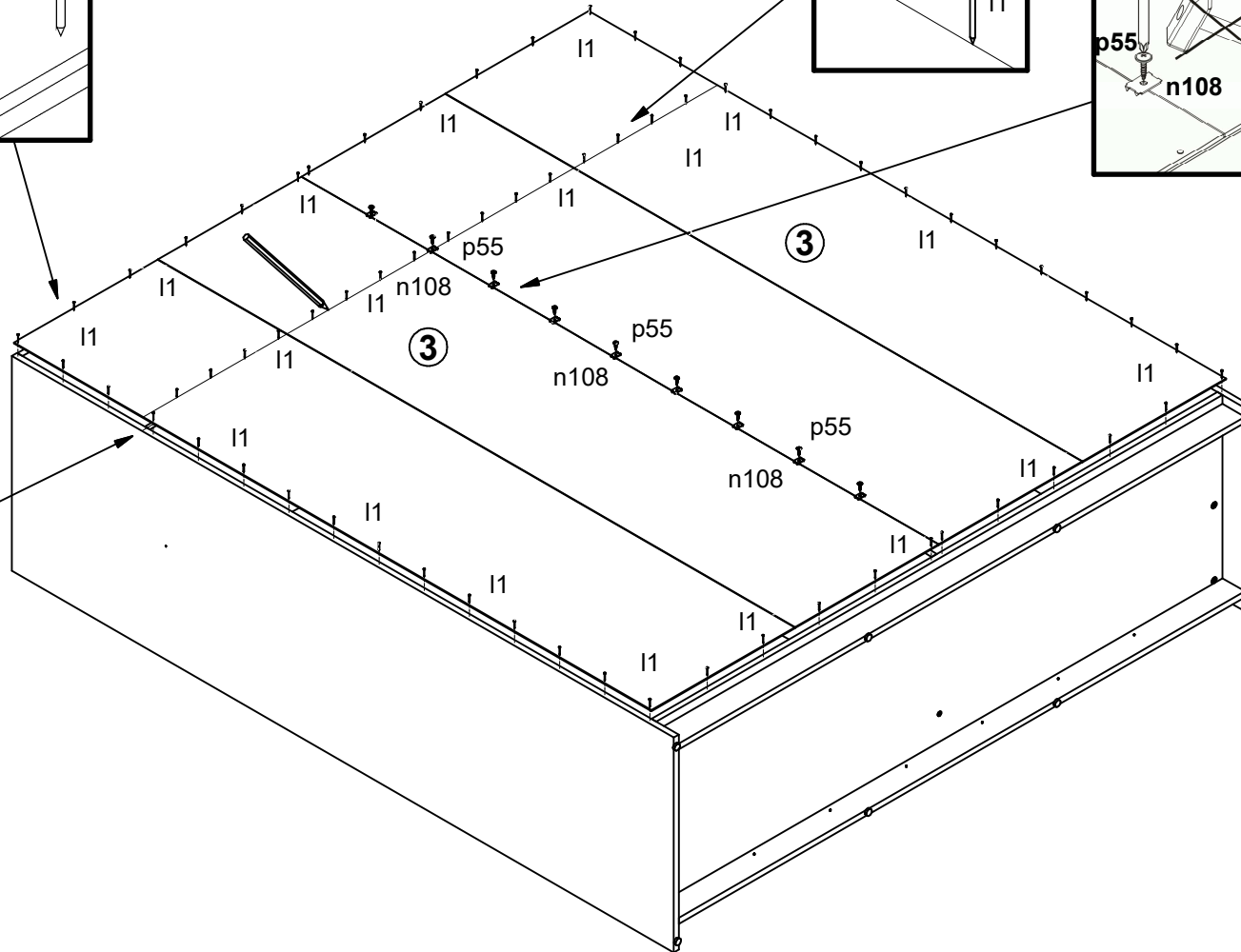
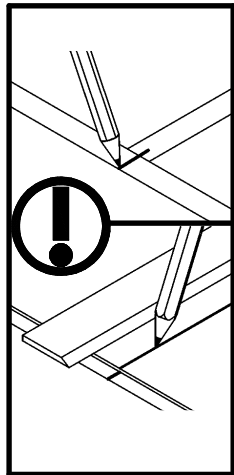
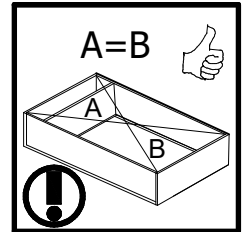
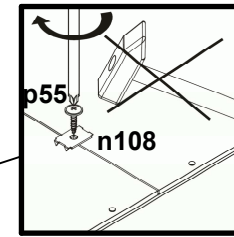
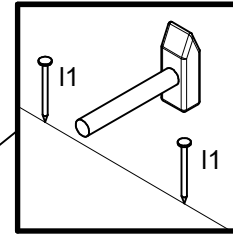
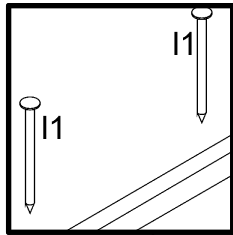

- 85x  l1
1.4x20 mm
- 9x  n108
22x9.5x20,7 mm
- 9x  p55
Ø2,9x16 mm

6

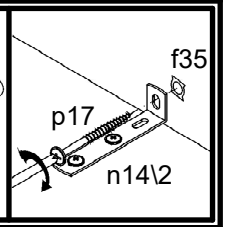
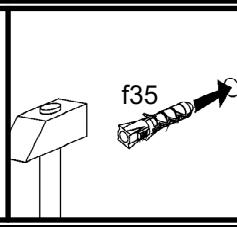
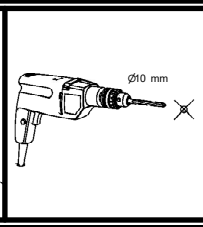
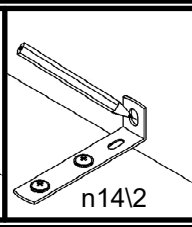
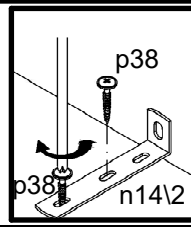
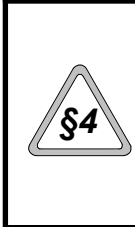
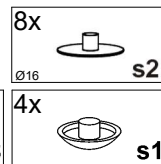
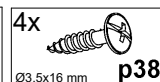
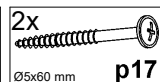
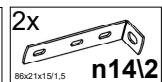
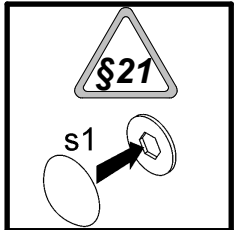
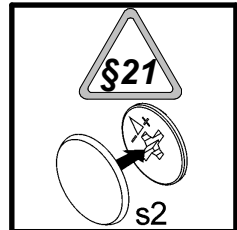
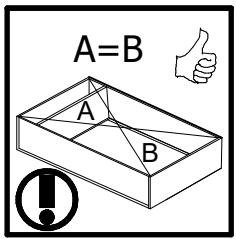
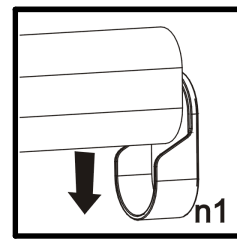
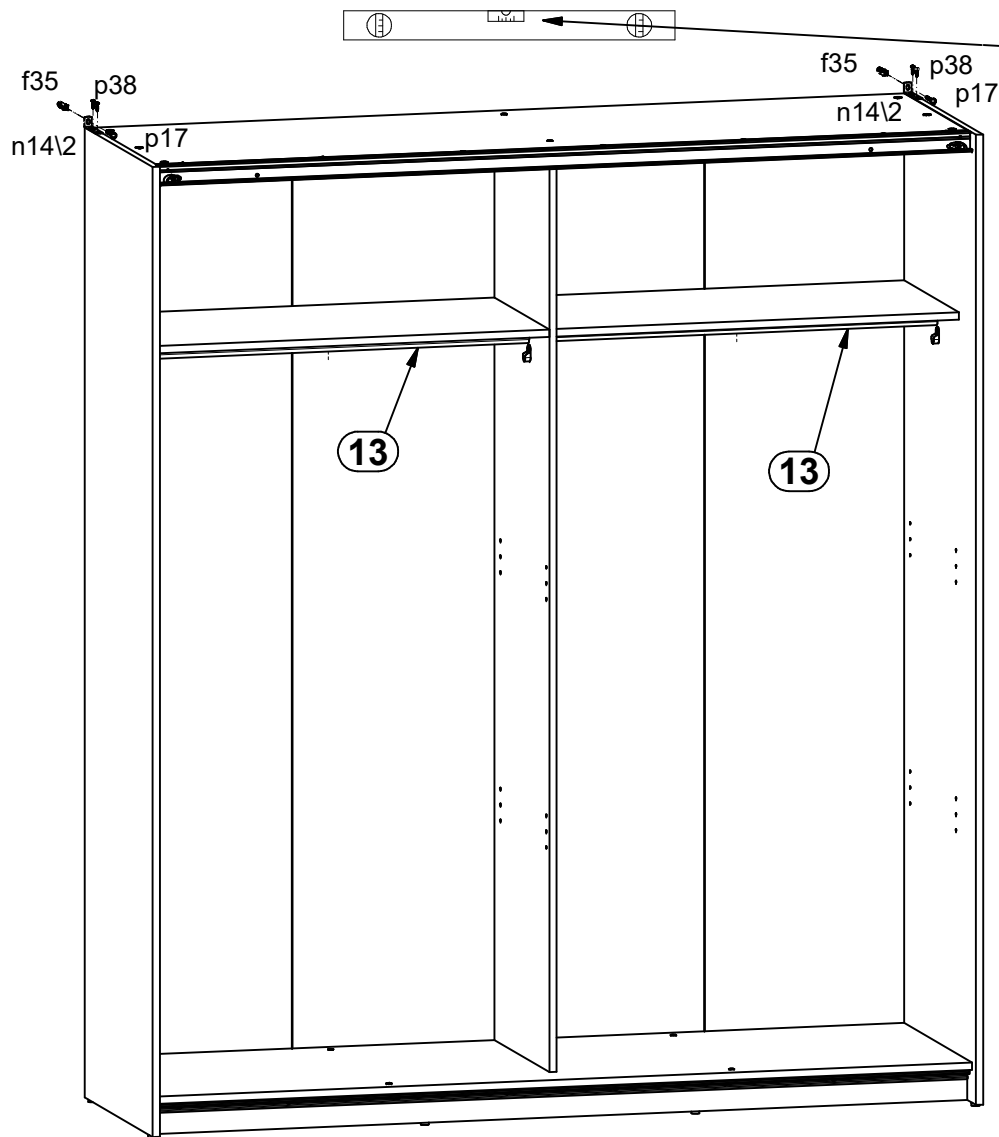

7

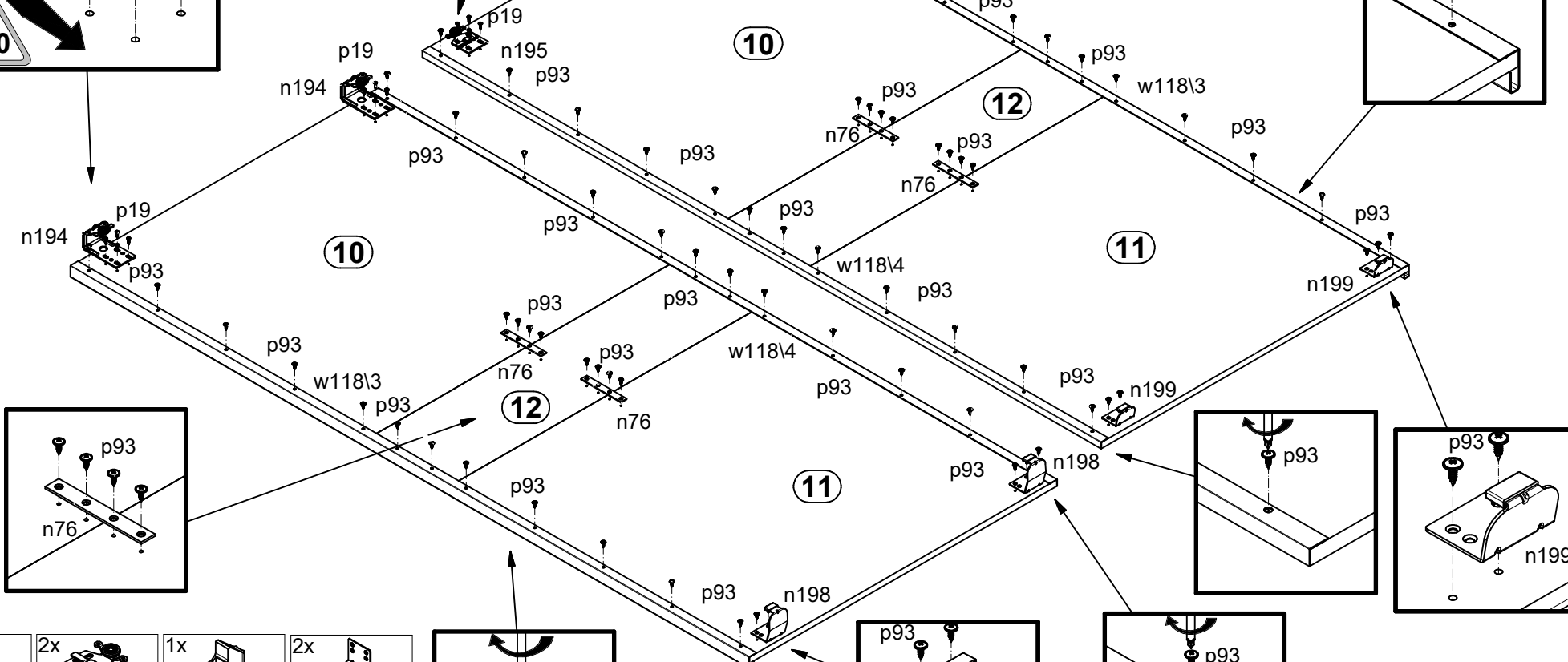
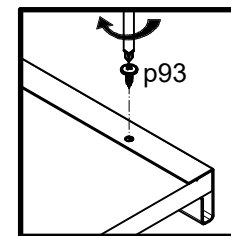
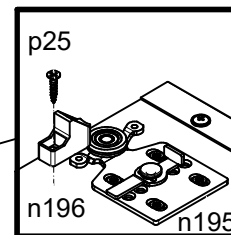
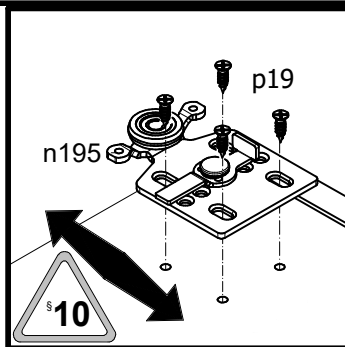
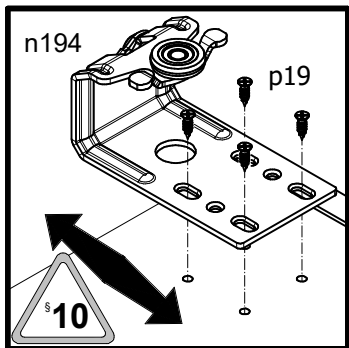

- | | | | |
|----------------------------|-------------------------------|-------------------------------|-----------------------------|
| 2x

n194 | 2x

n195 | 1x

n196 | 2x

n198 |
| 2x

n199 | 4x

n76 | 16x

p19
Ø4x16 mm | 1x

p25
Ø3.5x16 mm |
| 72x

p93
Ø4x13 mm | 2x

w118\3
L=1900 mm | 2x

w118\4
L=1900 mm | |

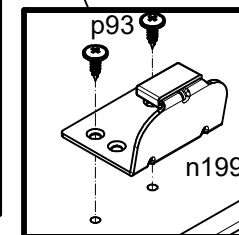
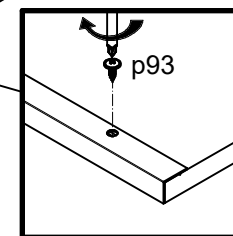
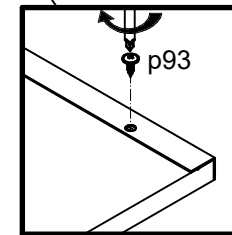
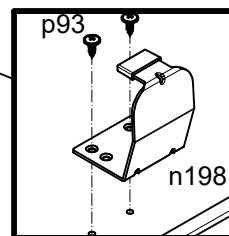
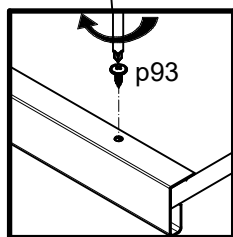

8

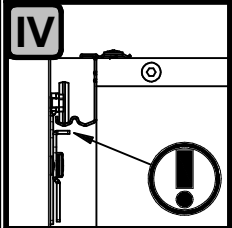
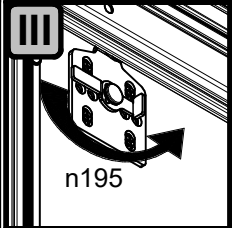
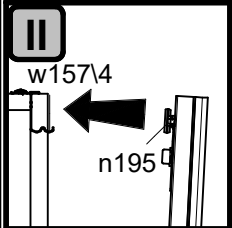
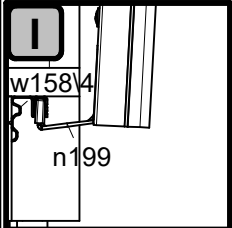
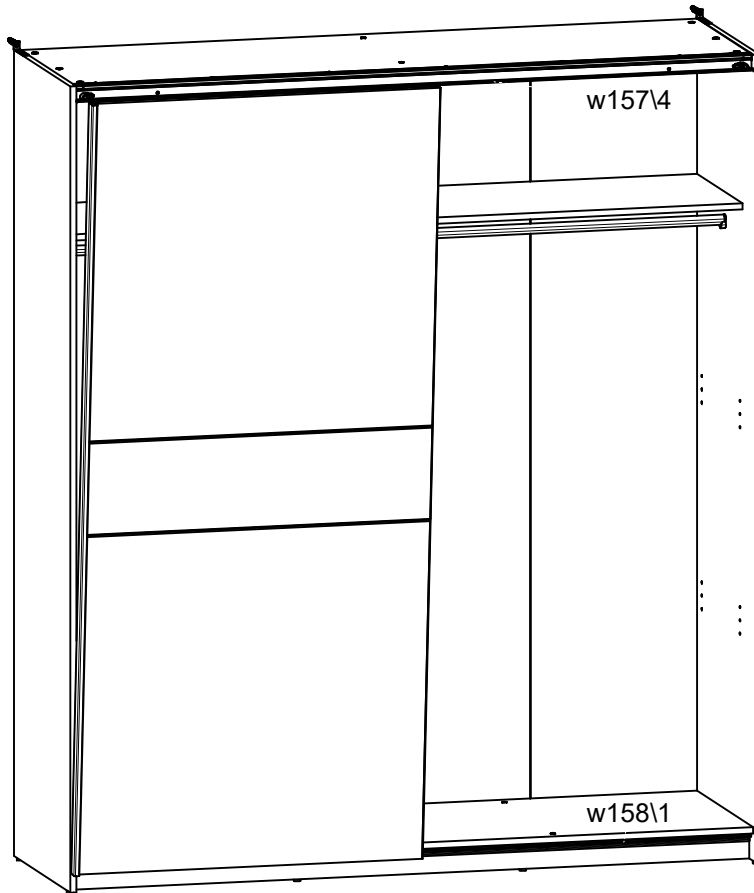

9

